

ASSEMBLY INSTRUCTIONS

FOR YOUR DB 9510 DAYBED KIT

THIS CRIB CONFORMS TO APPLICABLE
REGULATIONS PROMULGATED BY THE
CONSUMER PRODUCT SAFETY COMMISSION

(PLEASE REFER TO "ASSEMBLY INSTRUCTIONS FOR YOUR 9510 STATIONARY CRIB")

If you don't have your assembly manual anymore, you can download a copy from the "Assembly manuals" section of our website www.rominakidsfurniture.com or request one at contact@rominakidsfurniture.com.

WARNING: THE PROPER USE OF THIS CRIB IS IMPORTANT FOR YOUR BABY'S SAFETY. TO KEEP YOUR BABY SECURE AND SAFE, AND TO AVOID POTENTIAL INJURY OR DEATH, CAREFULLY READ AND FAMILIARIZE YOURSELF WITH ALL WARNINGS, CAUTIONS AND INSTRUCTIONS IN THE INSTRUCTION BOOKLET. KEEP THIS INSTRUCTION BOOKLET FOR FUTURE USE.

- ANY MATTRESS USED IN THIS CRIB MUST BE AT LEAST 27 1/4 IN BY 51 5/8 IN BY 4 IN, WITH A THICKNESS NOT EXCEEDING 6 IN.
- THE MINIMUM AGE OF YOUR CHILD SHALL NOT BE LESS THAN 15 MONTHS AND THE MAXIMUM WEIGHT SHALL NOT BE GREATER THAN 50LB.

DO NOT THROW OUT THIS INSTRUCTION BOOKLET

IMPORTANT:
PLEASE, READ ALL INSTRUCTIONS
BEFORE ASSEMBLING!
PLEASE, SAVE INSTRUCTIONS FOR
FUTURE USE



20 Corporation Row, Edison, NJ 08817
Phone (718) 478 5100, Fax (718) 478 5117
www.rominafurniture.com

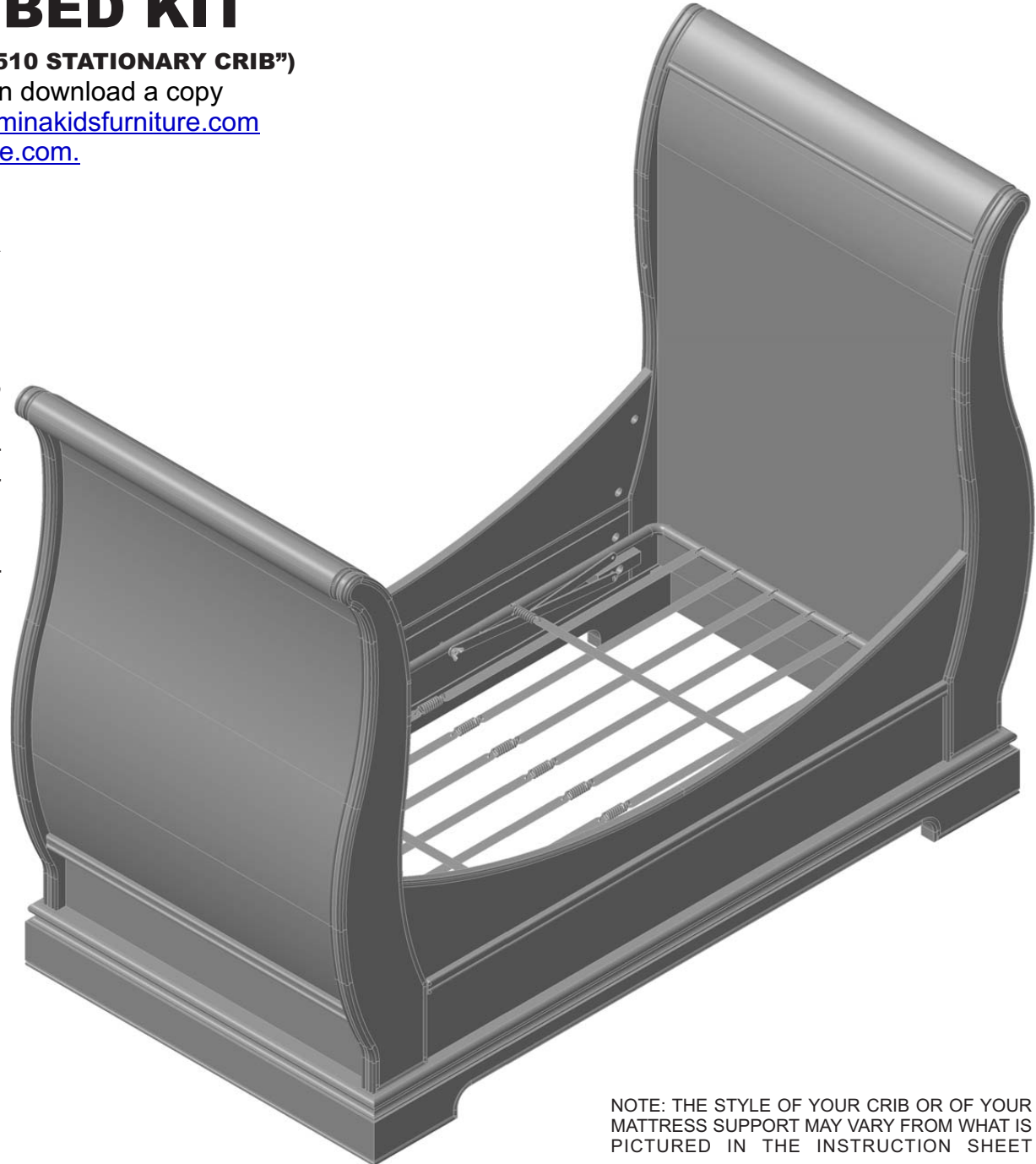

NOTE: THE STYLE OF YOUR CRIB OR OF YOUR MATTRESS SUPPORT MAY VARY FROM WHAT IS PICTURED IN THE INSTRUCTION SHEET

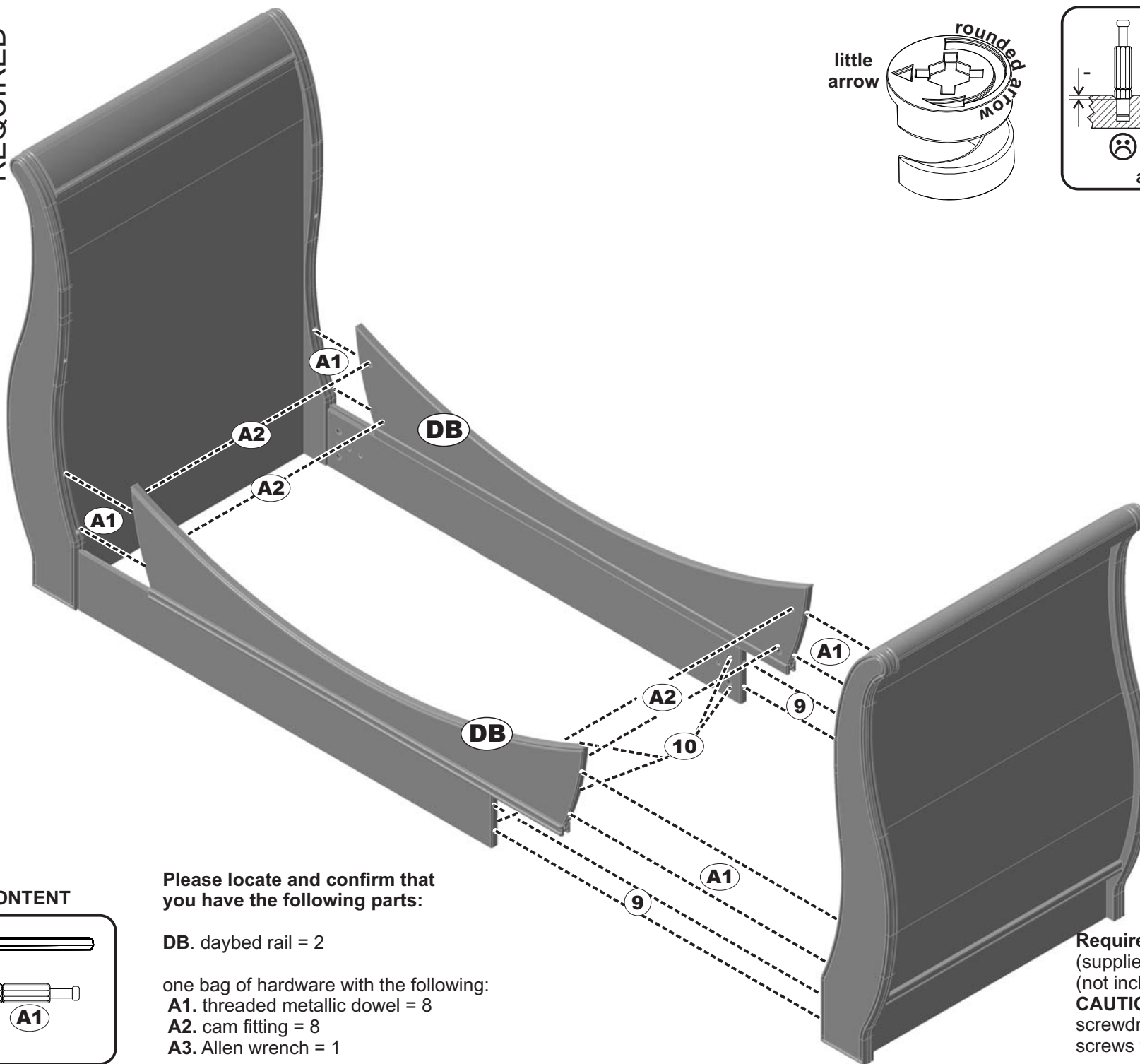
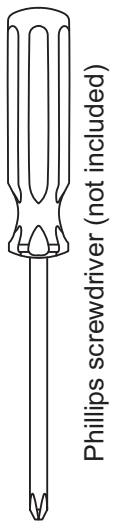
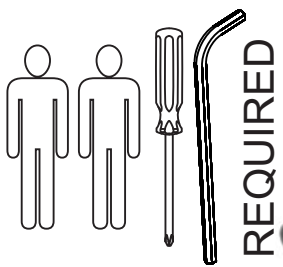

HARDWARE BOX CONTENT

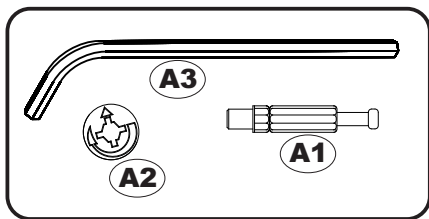

Please locate and confirm that you have the following parts:

DB. daybed rail = 2

one bag of hardware with the following:

A1. threaded metallic dowel = 8

A2. cam fitting = 8

A3. Allen wrench = 1

little arrow

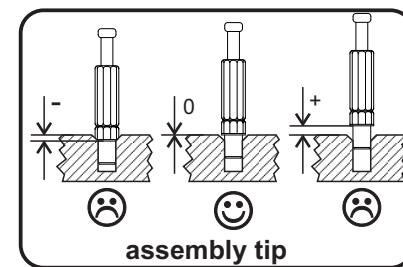
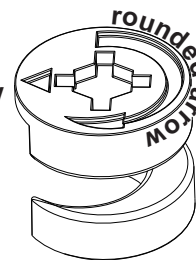

Required tools: Allen wrench (supplied), Phillips screwdriver (not included).

CAUTION: Do not use a power screwdriver which can cause screws to break or strip.

STEP A (Two adults are required to complete this step)

Disassemble the crib by following in reverse order **STEP 7** to **STEP 2** from “**ASSEMBLY INSTRUCTIONS FOR YOUR 9510 STATIONARY CRIB**”.

STEP B (Two adults are required to complete this step)

Using a Phillips screwdriver (not supplied) or just the hand insert eight metallic dowels (**A1**) into the middle threaded inserts from the end panels, assuming that the dowels for the lower panels (**9**) are still in position. Please see the assembly tip for dowel correct positioning.

Insert eight cam fittings (**A2**) into the bigger holes located in the daybed rails (**DB**) taking care that the little arrow of the cam is pointing to the nearest end of the rail.

Attach the daybed rails (**DB**) to the end & lower panels (**EP**) & (**LP**) as they resulted after completing **STEP 1** from “**ASSEMBLY INSTRUCTIONS FOR YOUR 9510 STATIONARY CRIB**”.

Then using the supplied Allen wrench and moderate force, slightly rotate the cams (**A2**) clockwise (see the cam’s rounded arrow) by about 90 deg to 120 deg until become tight.
Do not over-tight the cams! This is not a fixture involved in your child safety.

Carefully store the resulted upper panels in a proper place, away from direct sunlight and moisture, taking care not to scratch the wood finish.

STEP C (Two adults are required to complete this step)

Attach the other end panel (**EP**) to the part of your crib as it resulted after completing **STEP A & B** then, using the supplied Allen wrench and moderate force, slightly rotate the cams (**A2 & 10**) clockwise (see the cam’s rounded arrow) by about 90 deg to 120 deg until become tight.

Do not over-tight the cams! This is not a fixture involved in your child safety.

Remember: the resulted hardware is not a toy!
You must keep this hardware in a proper place, away from your children.

STEP D (Two adults are required to complete this step)

Follow **STEP 4** to **STEP 7** from “**ASSEMBLY INSTRUCTIONS FOR YOUR 9510 STATIONARY CRIB**”.

When you reach **STEP 5** adjust the mattress support to it’s lowest position.

After completing **STEP D**, your crib should look like the one depicted on the first page of this instruction booklet.

GENERAL FURNITURE CARE TIPS

- Wood, like any natural material is likely to present variations of grain and texture which will result in slight color variations or richness in the finish. These differences make each Romina furniture item as beautiful and unique as you and your baby are.
- To preserve the initial appearance and functionality of your furniture, it is recommended that all furniture items be used in accordance with their intended design.
- Special water-based finishes are used to make this furniture safe for your baby. These finishes may be more delicate than those used on adult furniture thus requiring careful maintenance.
- Constant rubbing or mechanical interaction with sharp/hard objects such as belt buckles, jeans' zippers or buttons will likely damage the finish on your furniture. When placing or retrieving items onto the furniture, always set them down and pick them up, do not "slide" them. Items placed onto the horizontal surfaces must be moved/rotated to prevent discoloration in the finish.
- Exposure to extreme variations of environmental conditions such as humidity and temperature can affect the finish quality due to wood sudden expansion or shrinkage. It is recommended that the room temperature be maintained in between 65 and 75 degrees Fahrenheit and a relative humidity of 35 – 40 %. Do not place items which are too hot or too cold directly onto the finished surfaces!
- Use caution when using a humidifier or vaporizer. Excessive moisture is harmful to the furniture causing the finish to peel and the wood to warp.
- Wipe up spills promptly. If water or other liquids stay in contact with the furniture for a long period of time, they can cause the finish to turn white or discolor. Alcohol or solvent containing substances or materials will permanently damage the finish.
- In general, furniture should not be placed in front or too close to air-conditioning outlets, fireplaces, heaters or humidifiers. Direct sunlight and ultraviolet rays will cause colors to fade, affect the luster and smoothness of the finish and in most cases may cause hairline cracks in the finish. White finishes will yellow naturally over time; exposure to direct sunlight will accelerate this natural process. Please note that all wood essences will darken over time along with the natural aging process which is not considered to be a quality defect.
- To clean the furniture, use a damp cloth immediately followed by wiping with a dry cloth. Do not allow water to stay in contact with the finish as it will damage the finish.
- If you need to put your furniture into storage for any period of time, avoid placing it in damp basements or hot attics. Air flow around and under the furniture should be allowed. Do not place furniture too close to walls, do not stack anything on it and do not cover it entirely.
- When using a vinyl changing pad or similar plastic accessories, make sure to use a fabric felt underneath. Certain plastics have ingredients that can react with and damage the finish. It is recommended to rotate the changing pad's position frequently to avoid finish discoloration.

Regular cleaning with mild soap on a soft cloth, followed by a clean damp cloth, then a dry cloth, will preserve the original luster and beauty of the fine finish of your Romina Furniture product.



Thank you for being one of our distinguished clients.

Romina[®] *Team*
Furniture

Visit
www.rominafurniture.com
for updates, special offers and more new designs.