

# ASSEMBLY INSTRUCTIONS FOR YOUR 4019 MIRROR ANTI-TILTING FEATURE

**IMPORTANT:**  
**PLEASE, READ ALL INSTRUCTIONS**  
**BEFORE ASSEMBLING!**  
**PLEASE, SAVE INSTRUCTIONS FOR**  
**FUTURE USE**

**WARNING:** THE PROPER FIXING OF YOUR MIRROR IS VERY IMPORTANT FOR YOUR BABY'S SAFETY. TO KEEP YOUR BABY SECURE AND SAFE, AND TO AVOID POTENTIAL INJURY OR DEATH, CAREFULLY READ AND FAMILIARIZE YOURSELF WITH ALL WARNINGS, CAUTIONS AND INSTRUCTIONS IN THIS INSTRUCTION BOOKLET. KEEP THIS INSTRUCTION BOOKLET FOR FUTURE USE.

**DO NOT THROW THIS INSTRUCTION BOOKLET.**

NOTE: THE STYLE OF YOUR MIRROR OR DRESSER MAY VARY FROM WHAT IS PICTURED IN THE INSTRUCTION SHEET

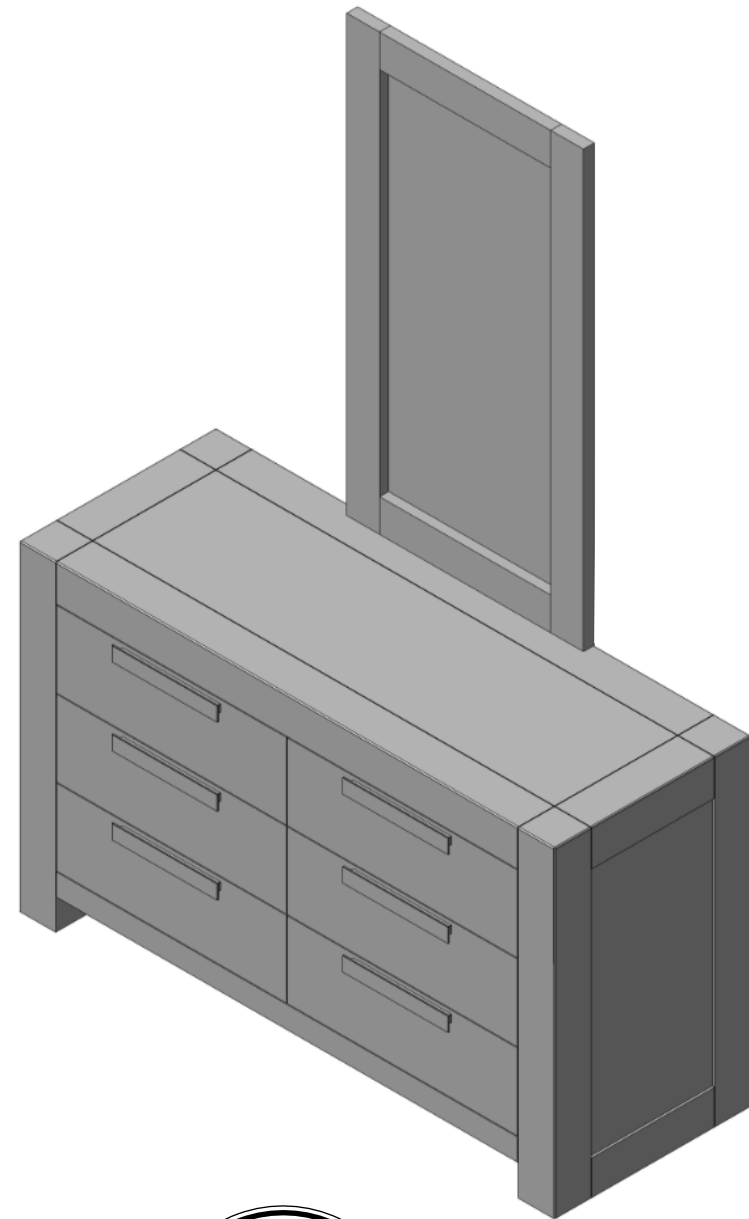

20 Corporation Row, NJ 08817  
Phone (718) 478-5100, Fax (718) 478-5117  
[www.rominafurniture.com](http://www.rominafurniture.com)

Please locate and confirm that you have the following parts:

1. metallic bracket = 2 pcs.
2. wood screw (35mm - 1 3/8") = 8 pcs.

**Required tools:** Phillips screwdriver (not supplied).  
**CAUTION: Do not use a power screwdriver which can cause screws or wood to break or strip.**

Position your mirror over the desired cabinet. Make sure that the mirror is evenly spaced between the left side and the right side of your cabinet and the back side of your mirror is aligned with the back side of the top of your cabinet. Attach the metallic brackets to the back side of the mirror using the pre-drilled holes. On the back side of the cabinet mark the position of the woodscrews which will fix the mirror then, using a 5/64" drill bit, drill pilot holes to prevent wood cracking when inserting the woodscrews. Fix the entire assembly to the back side of the cabinet. Completely tighten all the eight wood screws.

**CAUTION: ALWAYS USE BOTH METALLIC BRACKETS AND ALL THE EIGHT WOOD SCREWS TO FIX YOUR MIRROR TO THE CABINET!**

**WARNING:** TO KEEP YOUR BABY SECURE AND SAFE, AND TO AVOID POTENTIAL INJURY OR DEATH, **IT'S VERY IMPORTANT** TO COMPLETELY TIGHTEN ALL THE 8 WOOD SCREWS LISTED ABOVE.

**NOTE:** Only mirrors and hutches have pre-drilled holes on the back side for fixing the anti-tilting feature. The ROMINA cases are not pre-drilled.

