

ASSEMBLY INSTRUCTIONS

FOR YOUR 3515 TF & 3515 TT

NERVA BUNK BEDS

Romina[®]
Furniture

20 Corporation Row, Edison, NJ 08817
Phone (718) 478 5100, Fax (718) 478 5117
www.rominafurniture.com

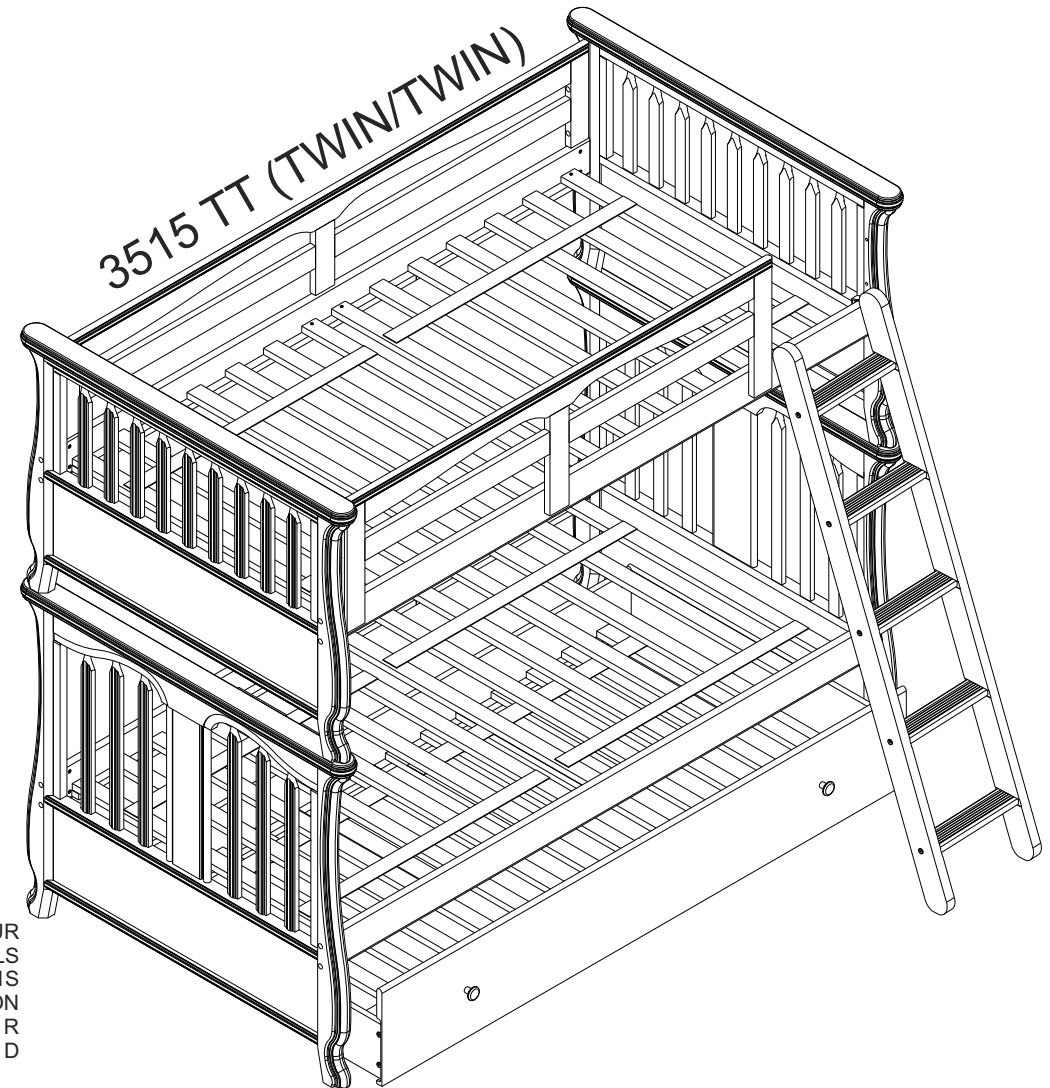
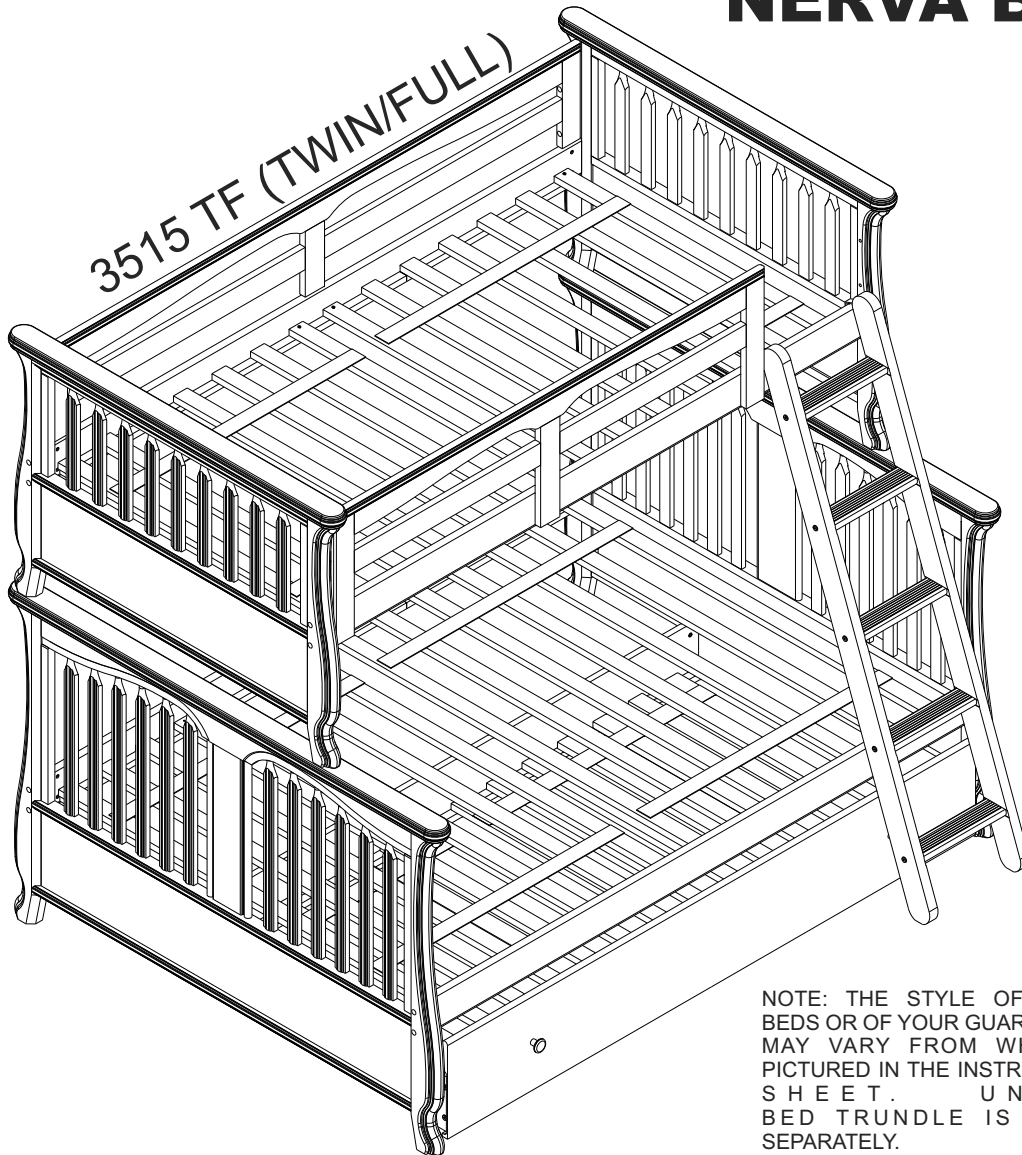

NOTE: THE STYLE OF YOUR BEDS OR OF YOUR GUARDRAILS MAY VARY FROM WHAT IS PICTURED IN THE INSTRUCTION SHEET. UNDER BED TRUNDLE IS SOLD SEPARATELY.

IMPORTANT:
PLEASE, READ ALL INSTRUCTIONS BEFORE ASSEMBLING!
PLEASE, SAVE INSTRUCTIONS FOR FUTURE USE



TO HELP PREVENT SERIOUS OR FATAL INJURIES FROM ENTRAPMENT OR FALLS:

- USE ONLY A TWIN SIZE MATTRESS ON UPPER BUNK, WITH A THICKNESS NOT EXCEEDING 8 1/4 IN.
- ALWAYS USE GUARDRAILS ON BOTH LONG SIDES OF UPPER BUNK.
- SURFACE OF MATTRESS MUST BE AT LEAST 5 IN. (127MM) BELOW THE UPPER EDGE OF GUARDRAILS.
- ALWAYS USE LADDER FOR ENTERING AND LEAVING UPPER BUNK.
- NEVER ALLOW A CHILD UNDER 6 YEARS ON UPPER BUNK.
- PROHIBIT HORSEPLAY AND JUMPING ON OR UNDER BED(S).
- PROHIBIT MORE THAN ONE PERSON ON UPPER BUNK.
- DO NOT USE THE UPPER BUNK IF THE GUARDRAILS AND THE LADDER ARE NOT PROPERLY ATTACHED AND FIXED IN THEIR PLACES.
- IF THE BUNK BED WILL BE PLACED NEXT TO A WALL, THE GUARDRAIL THAT RUNS THE FULL LENGTH OF THE BED SHOULD BE PLACED AGAINST THE WALL TO PREVENT ENTRAPMENT BETWEEN THE BED AND THE WALL.
- PERIODICALLY CHECK AND ENSURE THAT THE GUARDRAILS, LADDER AND OTHER COMPONENTS ARE IN THEIR PROPER POSITION, FREE FROM DAMAGE, AND THAT ALL CONNECTIONS ARE TIGHT.
- DO NOT SUBSTITUTE PARTS. PLEASE, CONTACT ROMINA FURNITURE DEALERS FOR REPLACEMENT PARTS.
- THE USE OF A NIGHT-LIGHT MAY PROVIDE ADDED SAFETY PRECAUTION FOR A CHILD USING THE UPPER BUNK.
- THE USE OF WATER OR SLEEP FLOTATION MATTRESSES IS PROHIBITED.
- PACKAGING MATERIAL, SMALL PARTS & PLASTIC BAGS ARE HAZARDOUS TO SMALL CHILDREN. PLEASE DISPOSE OF THEM IMMEDIATELY!
- REPLACEMENT PARTS, INCLUDING ADDITIONAL GUARDRAILS, MAY BE OBTAINED FROM ANY OF ROMINA FURNITURE DEALERS (SEE WWW.ROMINAFURNITURE.COM FOR DEALERS LIST)
- FOLLOW THE INFORMATION ON THE WARNINGS APPEARING ON THE UPPER BUNK END STRUCTURE AND ON THE CARTON. DO NOT REMOVE WARNING LABEL FROM BED.
- ALWAYS USE THE RECOMMENDED SIZE MATTRESS TO HELP PREVENT THE LIKELIHOOD OF ENTRAPMENT OR FALLS.
- STRANGULATION HAZARD** - NEVER ATTACH OR HANG ITEMS TO ANY PART OF THE BUNK BED THAT ARE NOT DESIGNED FOR USE WITH THE BED; FOR EXAMPLE, BUT NOT LIMITED TO, HOOKS, BELTS AND JUMP ROPES.

KEEP THESE INSTRUCTIONS FOR FUTURE REFERENCE!

3515 TT BOX CONTENT

Please locate and confirm you have the following parts:

- TF. "twin" type footboard = 2
- TH. "twin" type headboard = 2
- R. rails = 4
- S. group of 7 support slats assembled with 2 textile ribbons = 4
- SG. short guardrail = 1
- LG. long guardrail = 1
- LS. ladder stairs = 5
- LR. ladder rails = 2

One bag of hardware with the following:

1. Allen bolts (90mm - 3 1/2") = 16
2. barrel nuts = 16
3. Allen bolts (40mm - 1 9/16") = 10
4. wood screw (25mm - 1") = 8
5. wood screw (35mm - 1 3/8") = 16
6. wood screw (20mm - 3/4") = 6
7. wooden plugs = 16
8. steel pins = 4
9. ladder hooks = 2
10. Allen wrench = 1

Required tools: Allen wrench (supplied), Phillips screwdriver (not supplied), flat screwdriver (not supplied), hammer (not supplied)

CAUTION: Do not use a power screwdriver which can cause screws to break or strip

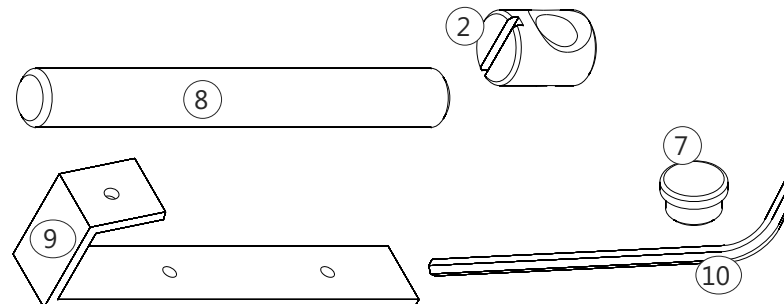
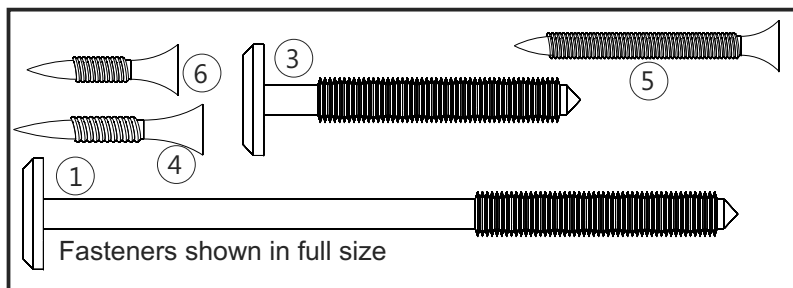
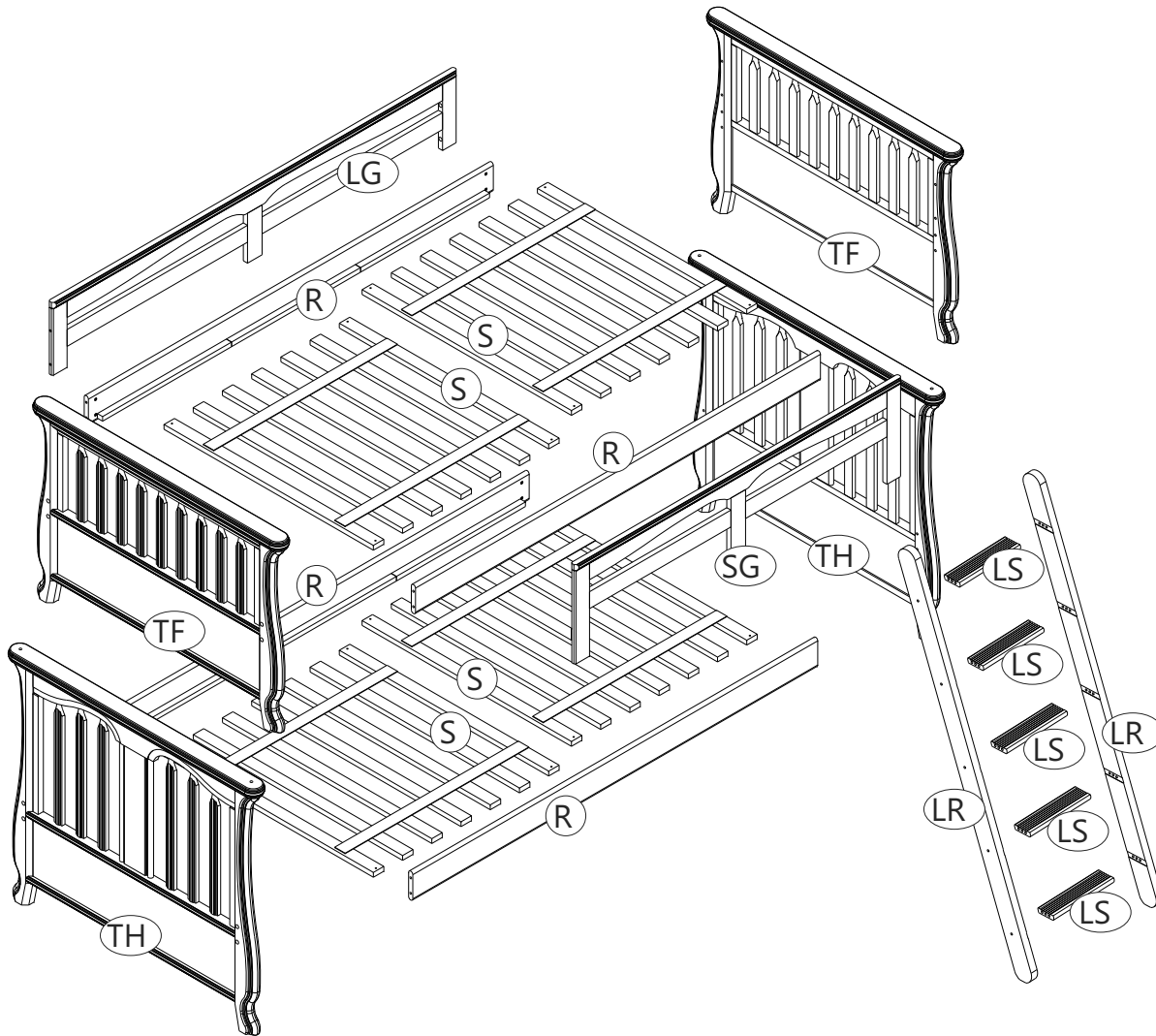

Note: The letter that identify a part is the first letter of the respective part name (such method is employed to facilitate parts recognition between the drawings and the parts list).

3515 TF BOX CONTENT

Please locate and confirm you have the following parts:

- TF. "twin" type footboard = 2
- FH. "full" type headboard = 2
- R. rails = 4
- S. group of 7 support slats assembled with 2 textile ribbons = 2+2
- SG. short guardrail = 1
- LG. long guardrail = 1
- LS. ladder stairs = 5
- LR. ladder rails = 2

One bag of hardware with the following:

1. Allen bolts (90mm - 3 1/2") = 16
2. barrel nuts = 16
3. Allen bolts (40mm - 1 9/16") = 10
4. wood screw (25mm - 1") = 8
5. wood screw (35mm - 1 3/8") = 16
6. wood screw (20mm - 3/4") = 6
7. wooden plugs = 16
8. steel pins = 4
9. ladder hooks = 2
10. Allen wrench = 1

Required tools: Allen wrench (supplied), Phillips screwdriver (not supplied), flat screwdriver (not supplied), hammer (not supplied)
CAUTION: Do not use a power screwdriver which can cause screws to break or strip

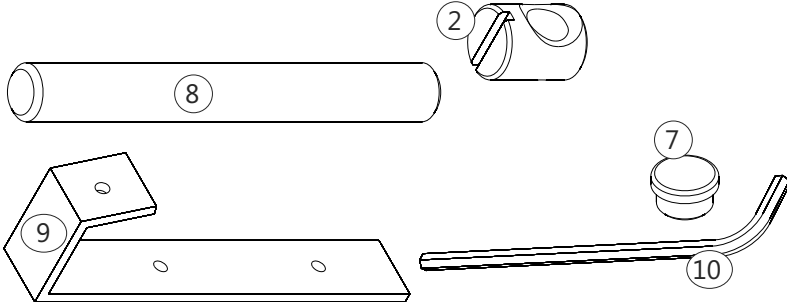
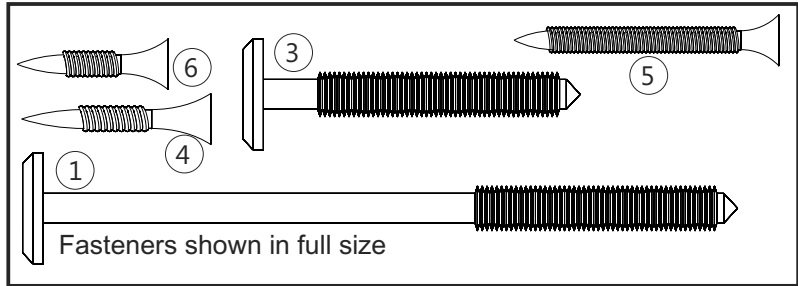
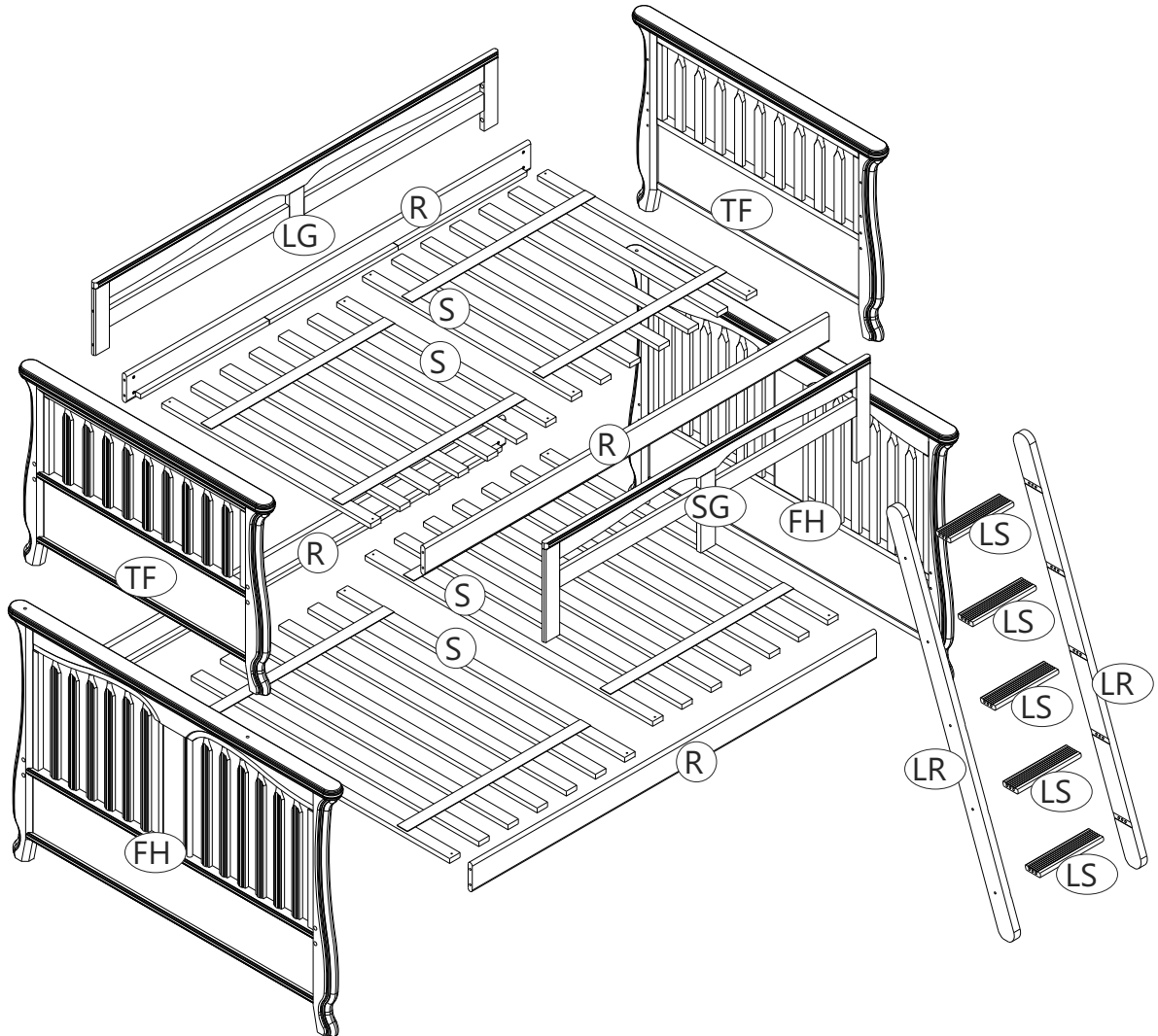

Note: The letter that identify a part is the first letter of the respective part name (such method is employed to facilitate parts recognition between the drawings and the parts list).

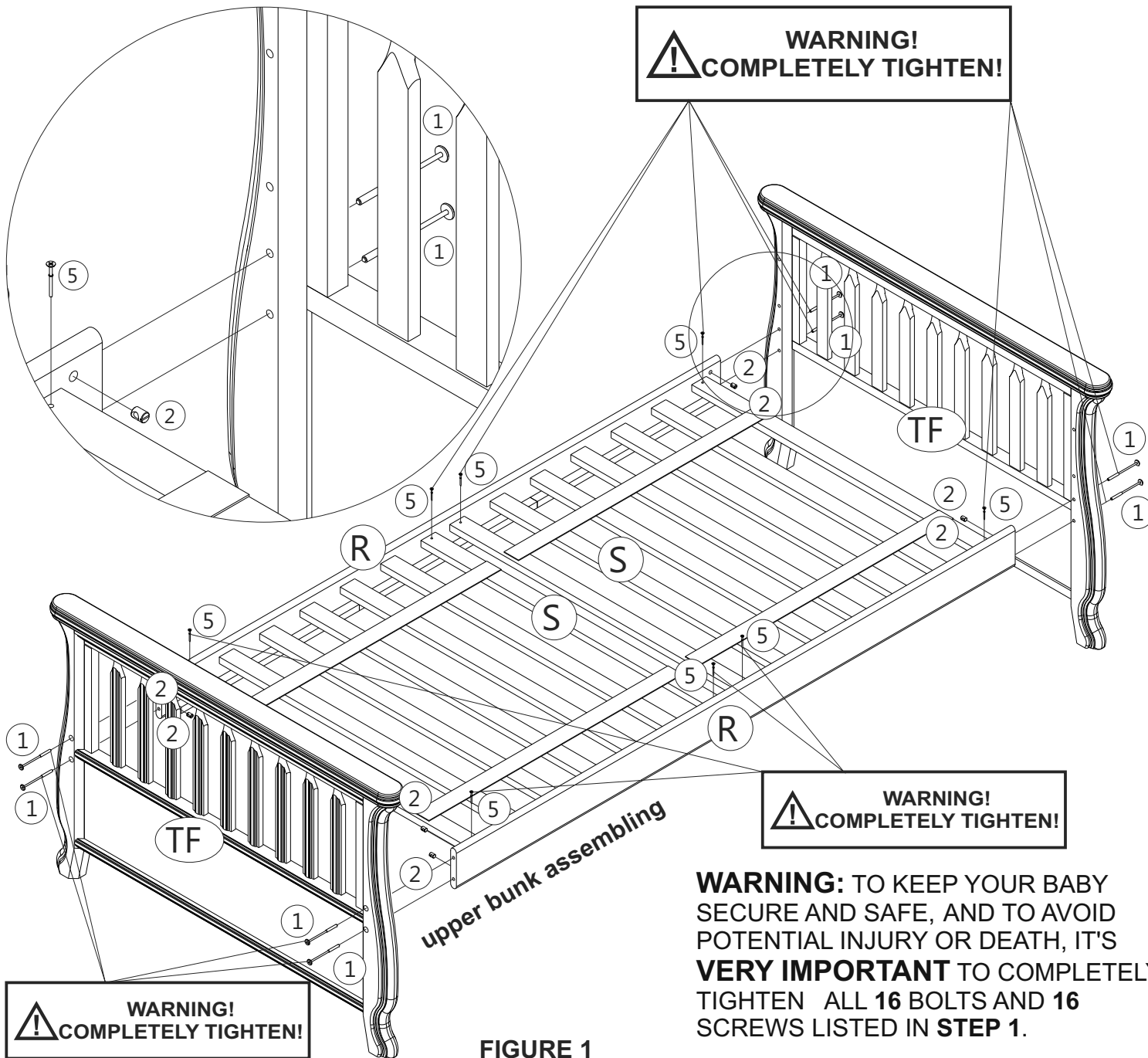

WARNING!
COMPLETELY TIGHTEN!

STEP 1

Assemble the bottom bunk first using 2 "full" type headboards (FH) for 3515 TF or 2 "twin" type headboards (TH) for 3515 TT and 2 rails (R). Use 8 longer Allen bolts (1), 8 barrel nuts (2) and the Allen wrench supplied (10).

Align the straight slots in the heads of the barrel nuts horizontally, so the threads in the bolt will insert in the barrel nut. You can adjust the position of the barrel nut with a flat head screwdriver (not supplied) or a coin. Push the Allen bolt through the headboard and into the rail. Start the threads by hand to assure you don't strip the threads.

Place 2 groups of 7 support slats (S) onto the wood brackets attached to the rails.

Make sure you firmly attach the support slats to the wood brackets with 8 longer wood screws (5). Use a Phillips screwdriver (not supplied) to firmly tighten the screws.

Make sure the slats are **EVENLY** spaced between the bed ends!

Use 2 "twin" footboards (TF), 2 rails (R) and 2 groups of 7 support slats (S) to assemble the upper bunk, using the same hardware and technique described above.

See **FIGURE 1** for details.

COMPLETELY TIGHTEN ALL THE BOLTS AND SCREWS USED AT THIS STEP!

WARNING!
COMPLETELY TIGHTEN!

WARNING: TO KEEP YOUR BABY SECURE AND SAFE, AND TO AVOID POTENTIAL INJURY OR DEATH, IT'S **VERY IMPORTANT** TO COMPLETELY TIGHTEN ALL 16 BOLTS AND 16 SCREWS LISTED IN **STEP 1**.

WARNING!
COMPLETELY TIGHTEN!

FIGURE 1

WARNING!
COMPLETELY TIGHTEN!

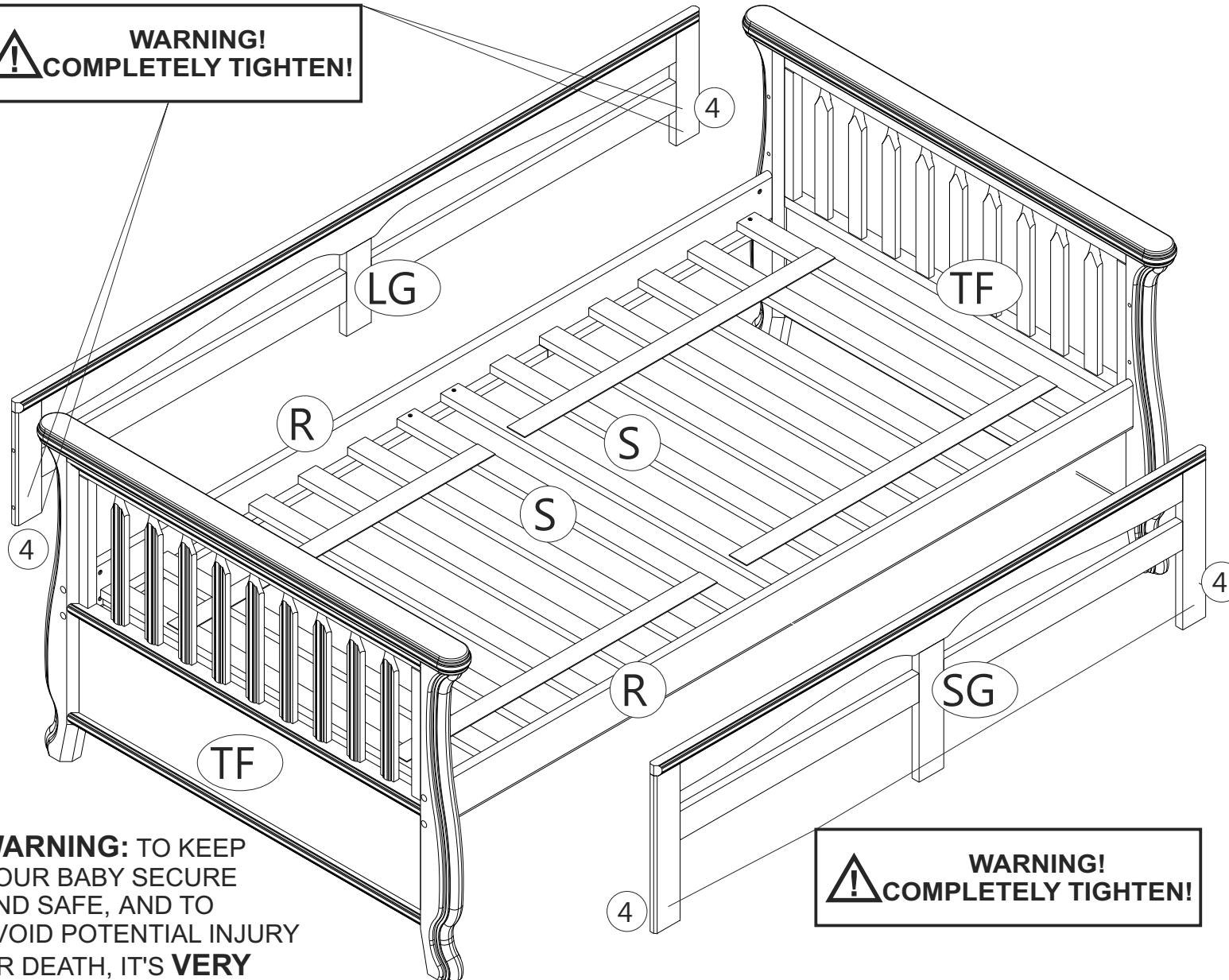

WARNING: TO KEEP YOUR BABY SECURE AND SAFE, AND TO AVOID POTENTIAL INJURY OR DEATH, IT'S **VERY IMPORTANT** TO COMPLETELY TIGHTEN ALL 8 SCREWS LISTED IN **STEP 2**.

STEP 2

Position the short guardrail on the desired side of the upper bunk **leaving no space** between the guardrail and the footboard, to leave room for the ladder on the other side of the bed then use **4 wood screws (4)** to secure the guardrail to the rail (**R**). Use a Phillips screwdriver (not supplied) to firmly tighten the wood screws. Attach the long guardrail to the upper bunk. Use **4 wood screws (4)** to secure the guardrail to the rail (**R**). **Completely tighten all the screws listed in STEP 2!**

WARNING!
COMPLETELY TIGHTEN!

SAFETY WARNING!
IF THE BUNK BED WILL BE PLACED NEXT TO A WALL, THE LONGER GUARDRAIL SHOULD BE PLACED AGAINST THE WALL TO PREVENT ENTRAPMENT BETWEEN THE BED AND THE WALL.

FIGURE 2

STEP 3

Insert 4 steel pins (8) in the holes provided on the top of each headboard (use a hammer if required). Stack the upper bunk on the top of bottom bunk by **completely** inserting the pins into the holes drilled in the bottom face of the footboards legs.

This step requires a helper for lifting the upper bunk.

WARNING: TO KEEP YOUR BABY SECURE AND SAFE, AND TO AVOID POTENTIAL INJURY OR DEATH, IT'S **VERY IMPORTANT** TO COMPLETELY INSERT ALL THE 4 STEEL PINS INTO THE HOLES DESCRIBED IN **STEP 3**, **LEAVING NO SPACE** BETWEEN THE UPPER BUNK AND THE BOTTOM BUNK!

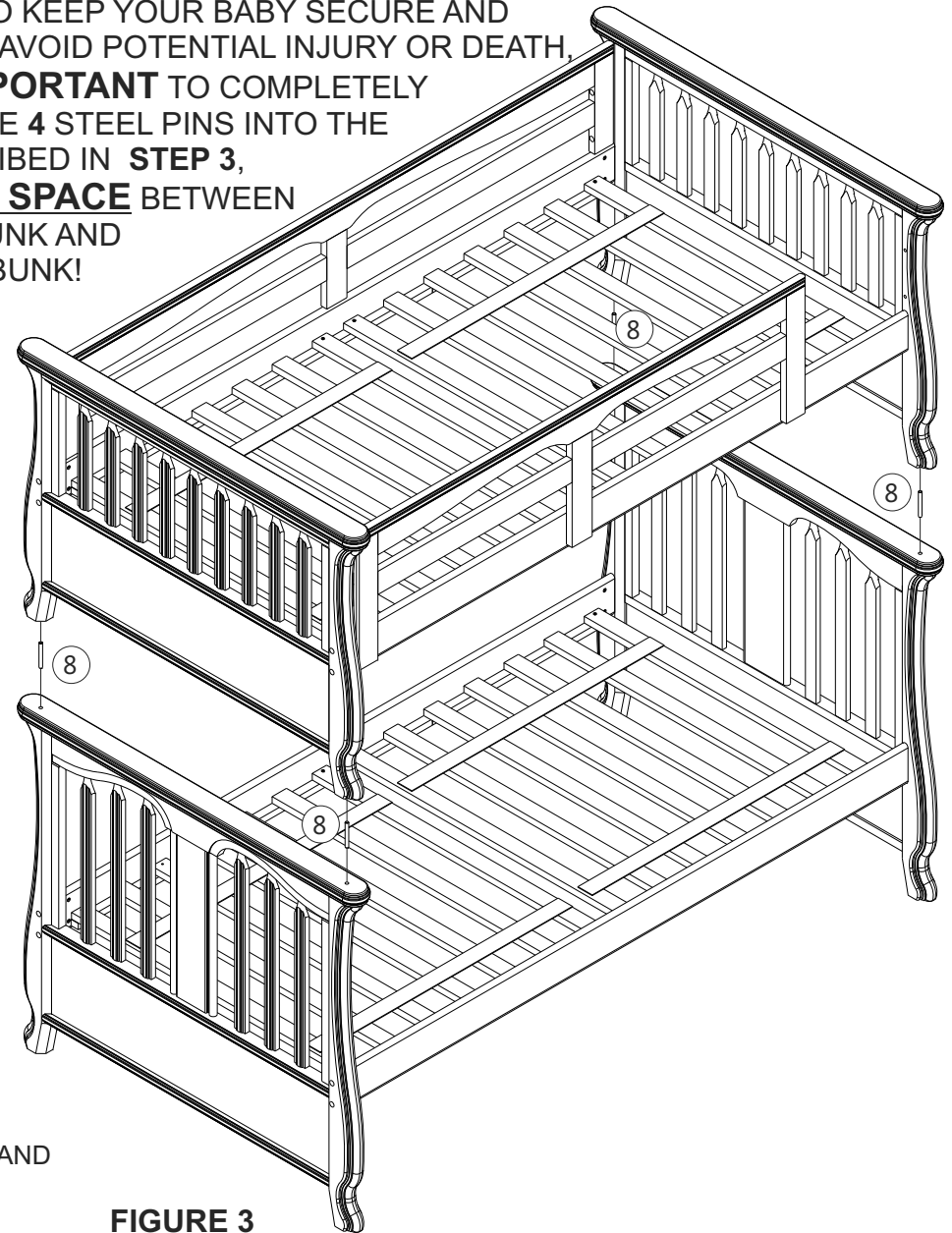
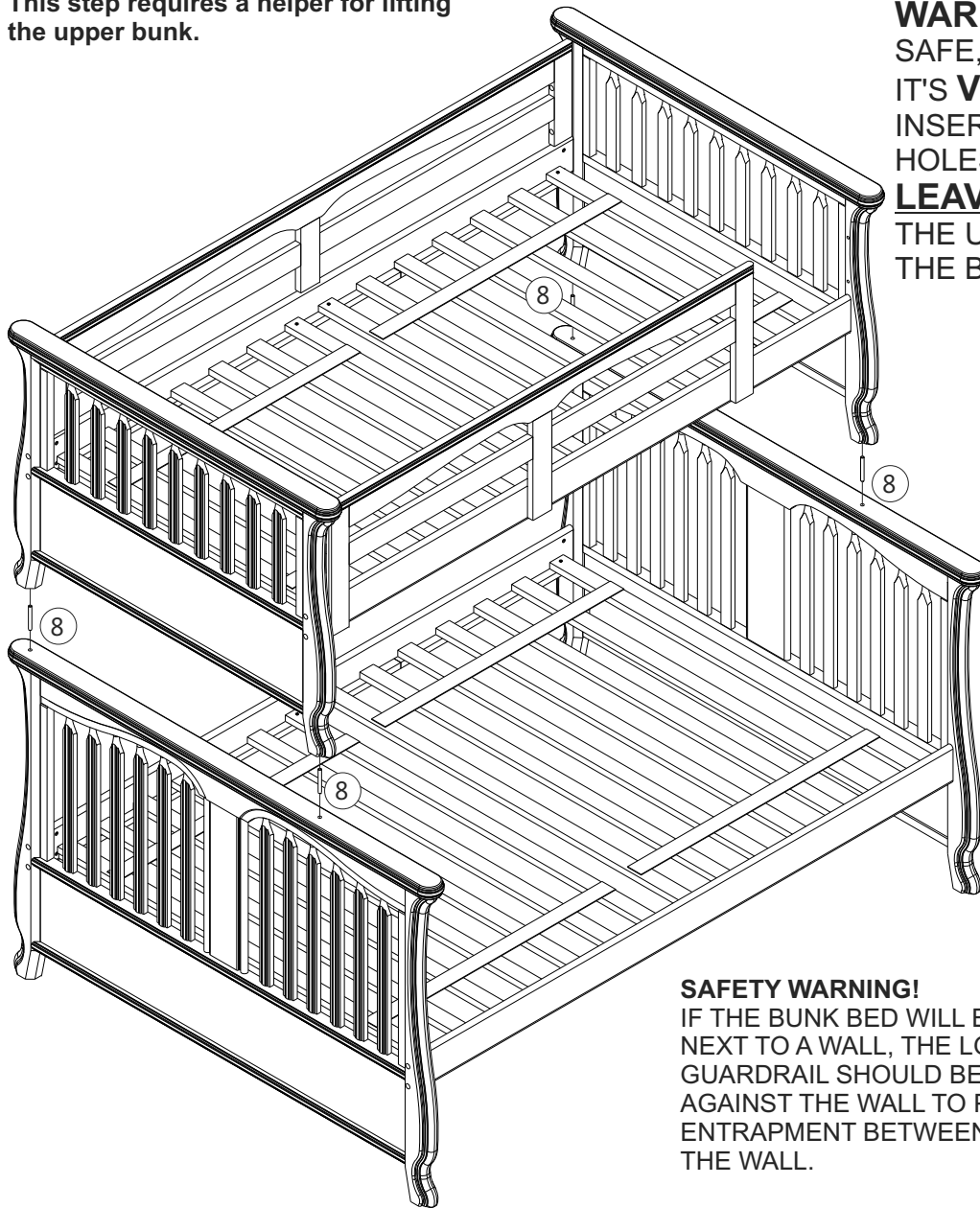

SAFETY WARNING!
IF THE BUNK BED WILL BE PLACED NEXT TO A WALL, THE LONGER GUARDRAIL SHOULD BE PLACED AGAINST THE WALL TO PREVENT ENTRAPMENT BETWEEN THE BED AND THE WALL.

FIGURE 3

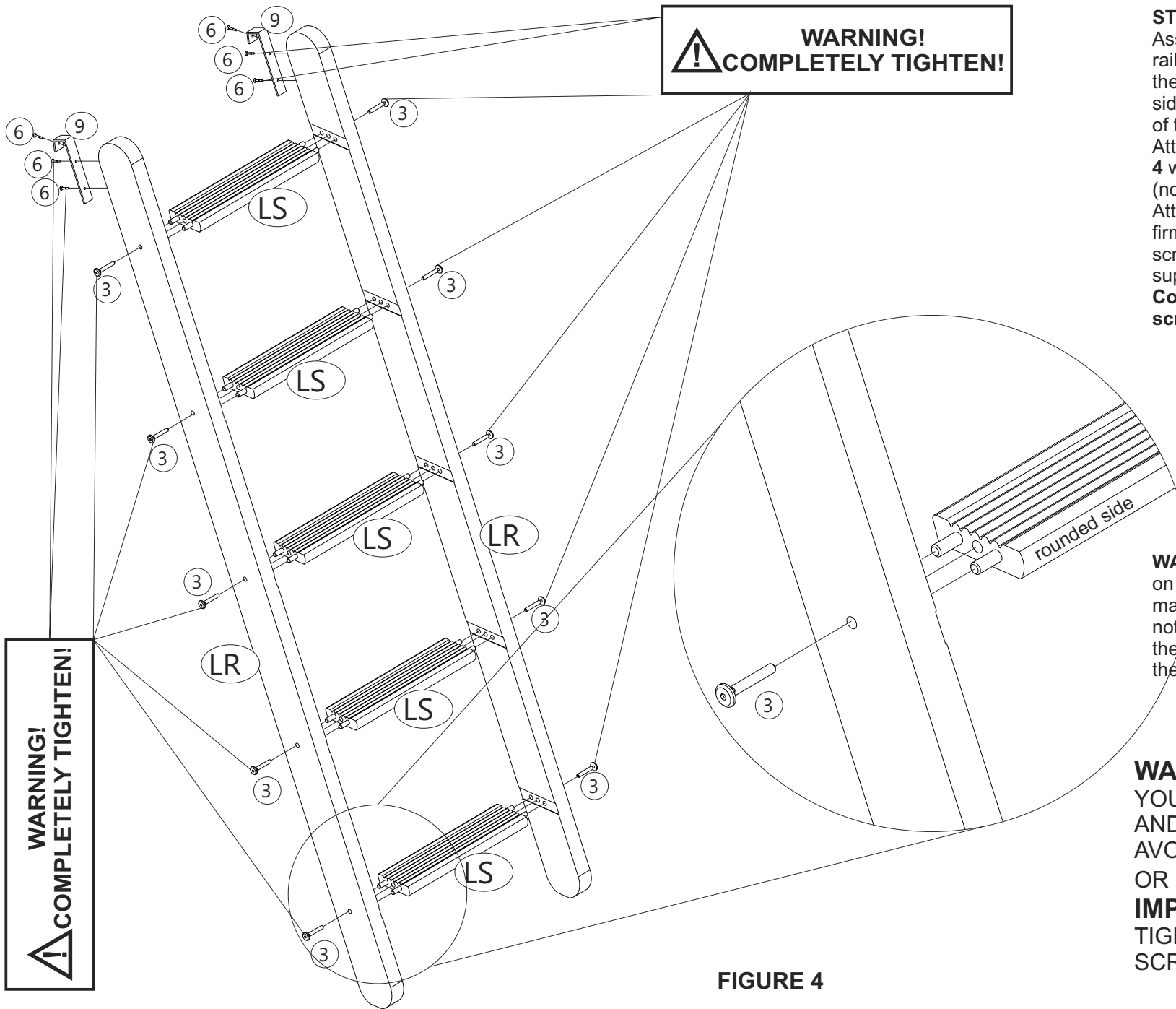

WARNING!
COMPLETELY TIGHTEN!

WARNING!
COMPLETELY TIGHTEN!

STEP 4

Assemble the ladder stairs (LS) with ladder rails (LR) using 10 shorter Allen bolts (3) and the supplied Allen wrench (10). The rounded side of the stairs must facing the outer side of the ladder.

Attach 2 ladder hooks (9) to the ladder with 4 wood screws (6) and a Phillips screwdriver (not supplied).

Attach the ladder to the upper bunk and firmly fix it on the upper rail using 2 wood screws (6) and a Phillips screwdriver (not supplied).

Completely tighten all the bolts and screws listed in STEP 4.

After completing **STEP 4** your bunk bed should look like the one depicted on **PAGE 1**.

WARNING! For maximum occupant safety on the upper bed use only a twin size mattress. Ensure thickness of mattress does not exceed **8 1/4"**. Make sure the surface of the upper bed mattress is at least **5"** below the upper edge of the guardrails.

WARNING: TO KEEP YOUR BABY SECURE AND SAFE, AND TO AVOID POTENTIAL INJURY OR DEATH, IT'S **VERY IMPORTANT** TO COMPLETELY TIGHTEN ALL **10 BOLTS** AND **6 SCREWS** LISTED IN **STEP 4!**

FIGURE 4

**ASSEMBLY INSTRUCTIONS
FOR YOUR 3515 & 3530
NERVA BEDS**

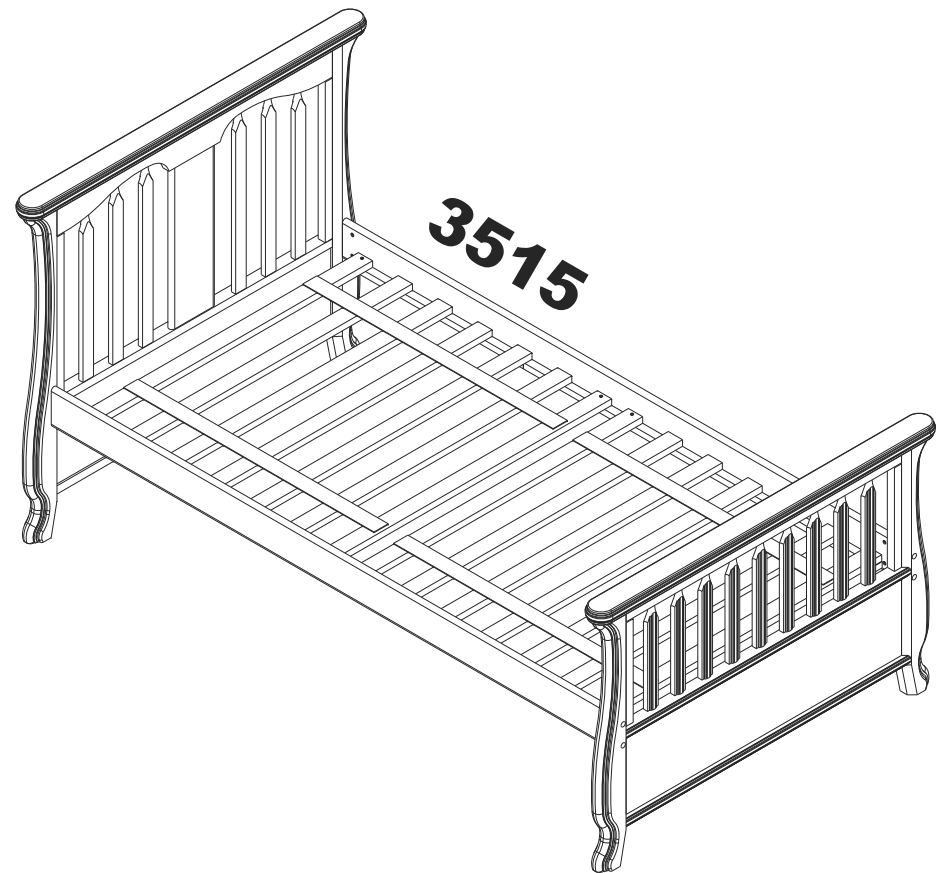
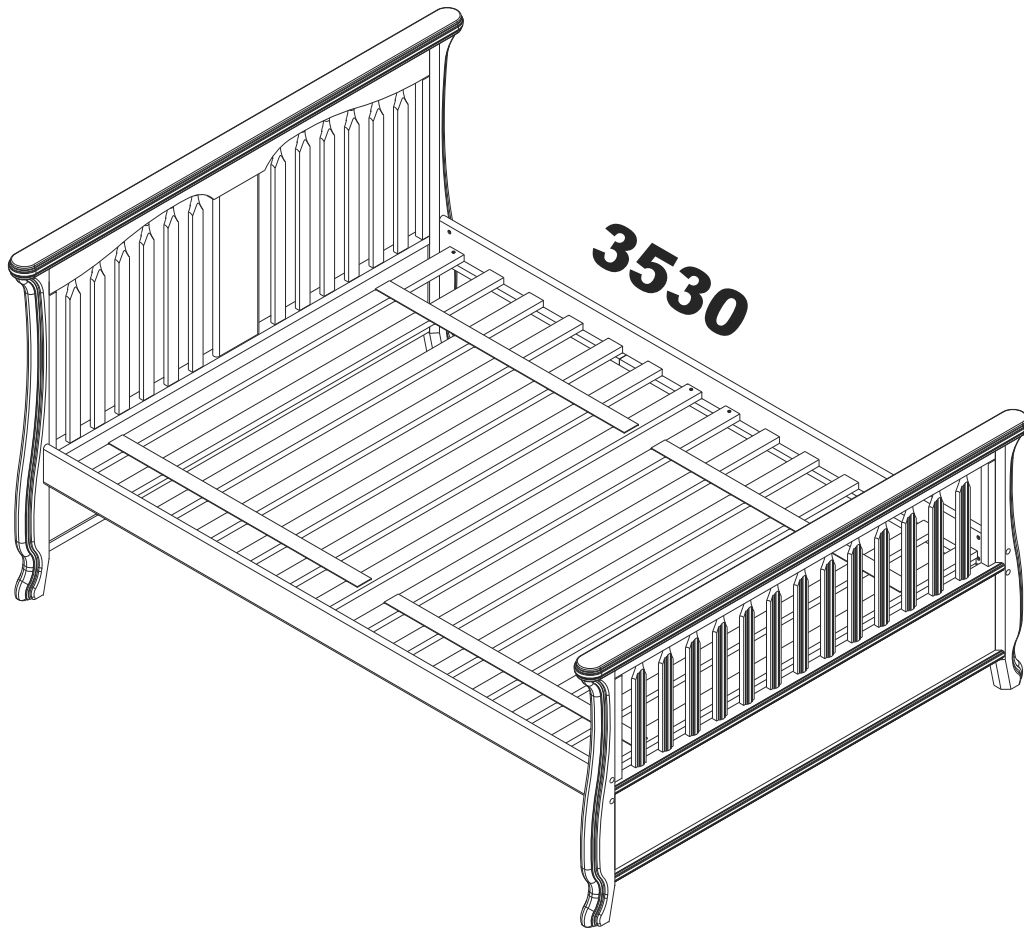

3530 BOX CONTENT

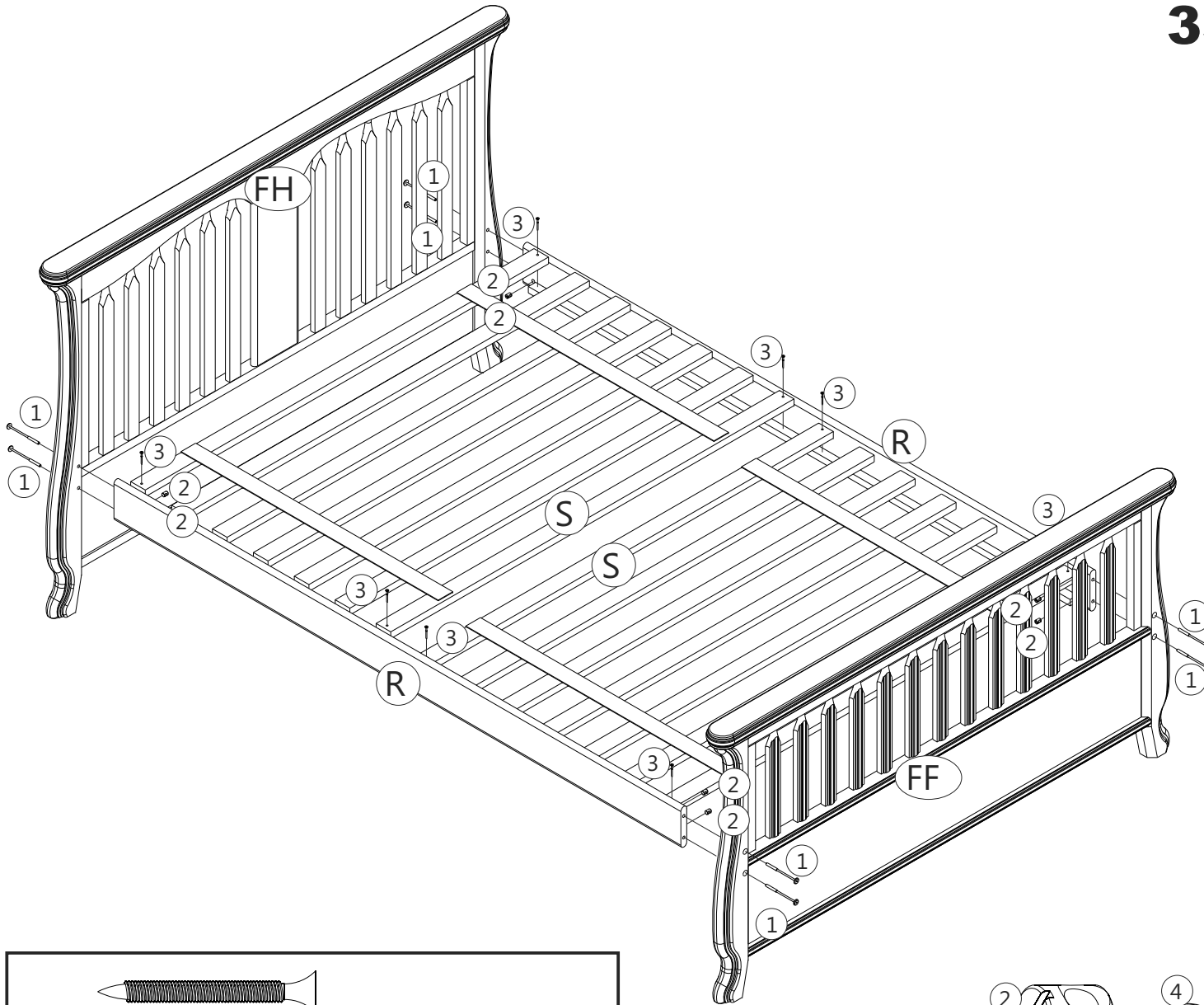

Please locate and confirm you have the following parts:

- FF. "full" type footboard = 1
- FH. "full" type headboard = 1
- R. rails = 2
- S. group of 7 support slats assembled with 2 textile ribbons = 2

One bag of hardware with the following:

1. Allen bolts (90mm - 3 1/2") = 8
2. barrel nuts = 8
3. wood screw (35mm - 1 3/8") = 8
4. wooden plugs = 8
5. Allen wrench = 1

Required tools: Allen wrench (supplied), Phillips screwdriver (not supplied), flat screwdriver (not supplied).

CAUTION: Do not use a power screwdriver which can cause screws to break or strip

Assemble your bed using the same technique described in **STEP 1** of the 3515 TF & 3515 TT assembling manual.

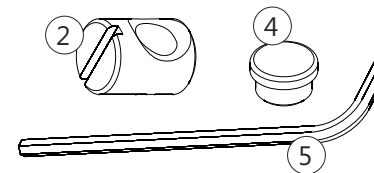
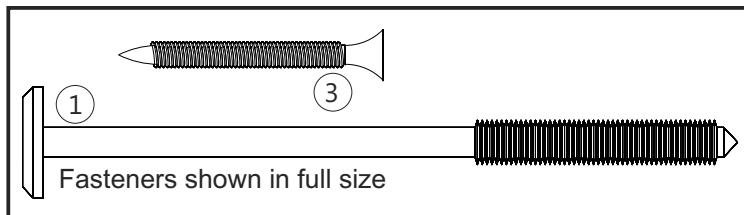

Note: The letter that identify a part is the first letter of the respective part name (such method is employed to facilitate parts recognition between the drawings and the parts list).

3515 BOX CONTENT

Please locate and confirm you have the following parts:

- TF. "twin" type footboard = 1
- TH. "twin" type headboard = 1
- R. rails = 2
- S. group of 7 support slats assembled with 2 textile ribbons = 2

One bag of hardware with the following:

- 1. Allen bolts (90mm - 3 1/2") = 8
- 2. barrel nuts = 8
- 3. wood screw (35mm - 1 3/8") = 8
- 4. wooden plugs = 8
- 5. Allen wrench = 1

Required tools: Allen wrench (supplied), Phillips screwdriver (not supplied), flat screwdriver (not supplied).

CAUTION: Do not use a power screwdriver which can cause screws to break or strip

Assemble your bed using the same technique described in **STEP 1** of the 3515 TF & 3515 TT assembling manual.

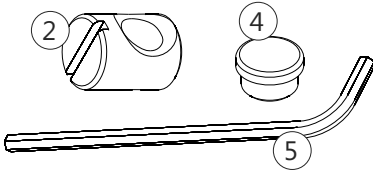
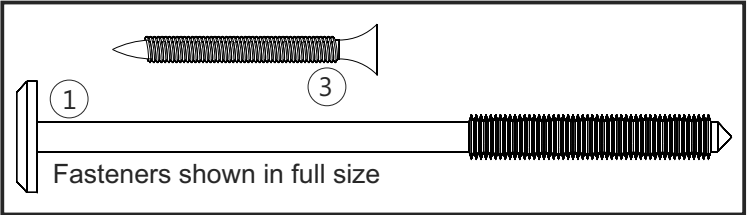
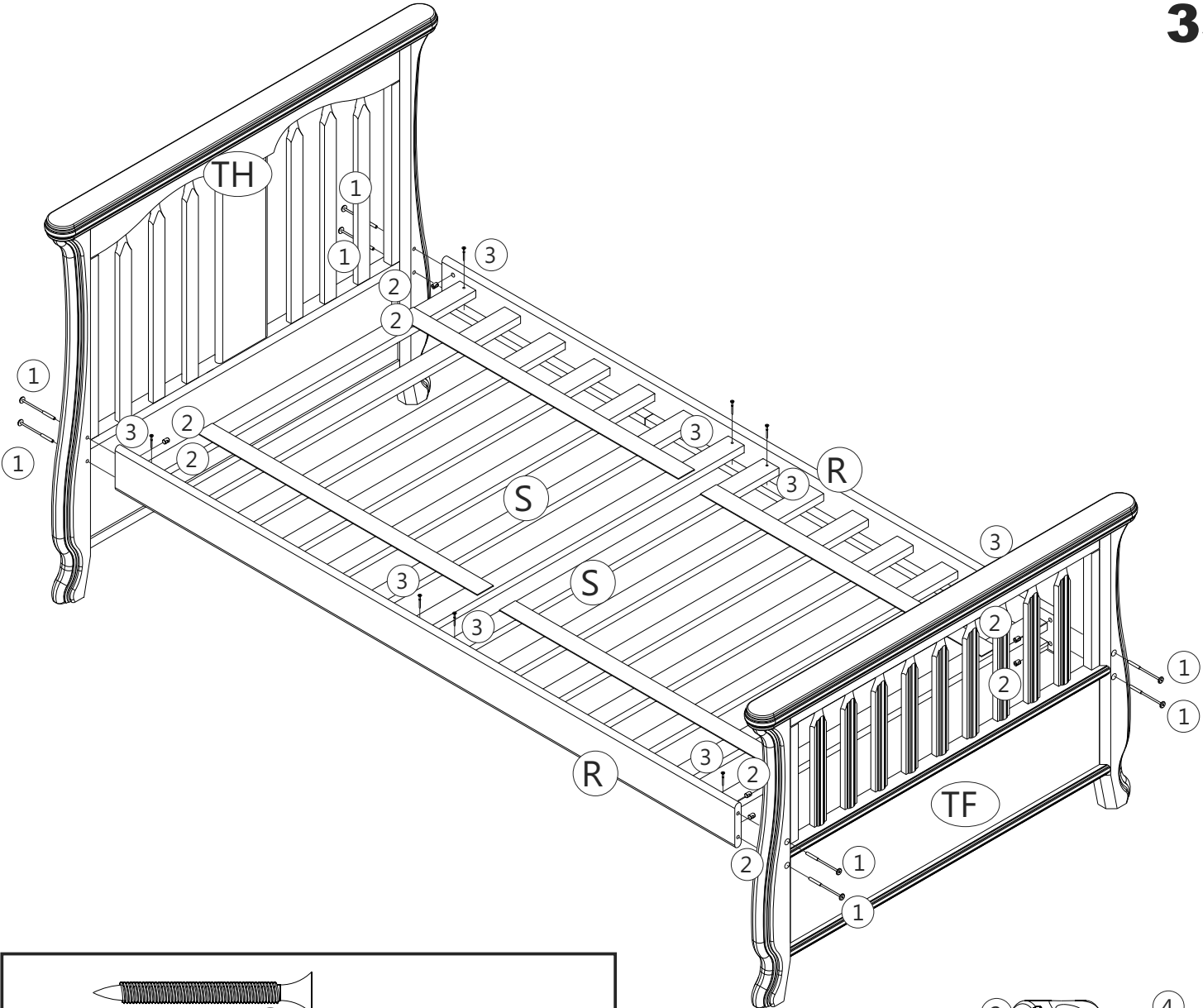

Note: The letter that identify a part is the first letter of the respective part name (such method is employed to facilitate parts recognition between the drawings and the parts list).

Regular cleaning with mild soap on a soft cloth, followed by a clean damp cloth, then a dry cloth, will preserve the original luster and beauty of the fine finish of your Romina Furniture product.



Thank you for being one of our distinguished clients.

Romina[®] *Team*
furniture

Visit

www.rominakidsfurniture.com
for updates, special offers and more new designs.