

these pictures shows how your beds
should look like after completing assembly

**DO NOT THROW THIS
INSTRUCTION BOOKLET**

ASSEMBLY INSTRUCTIONS FOR YOUR VERONA 2515 & 2530 BEDS

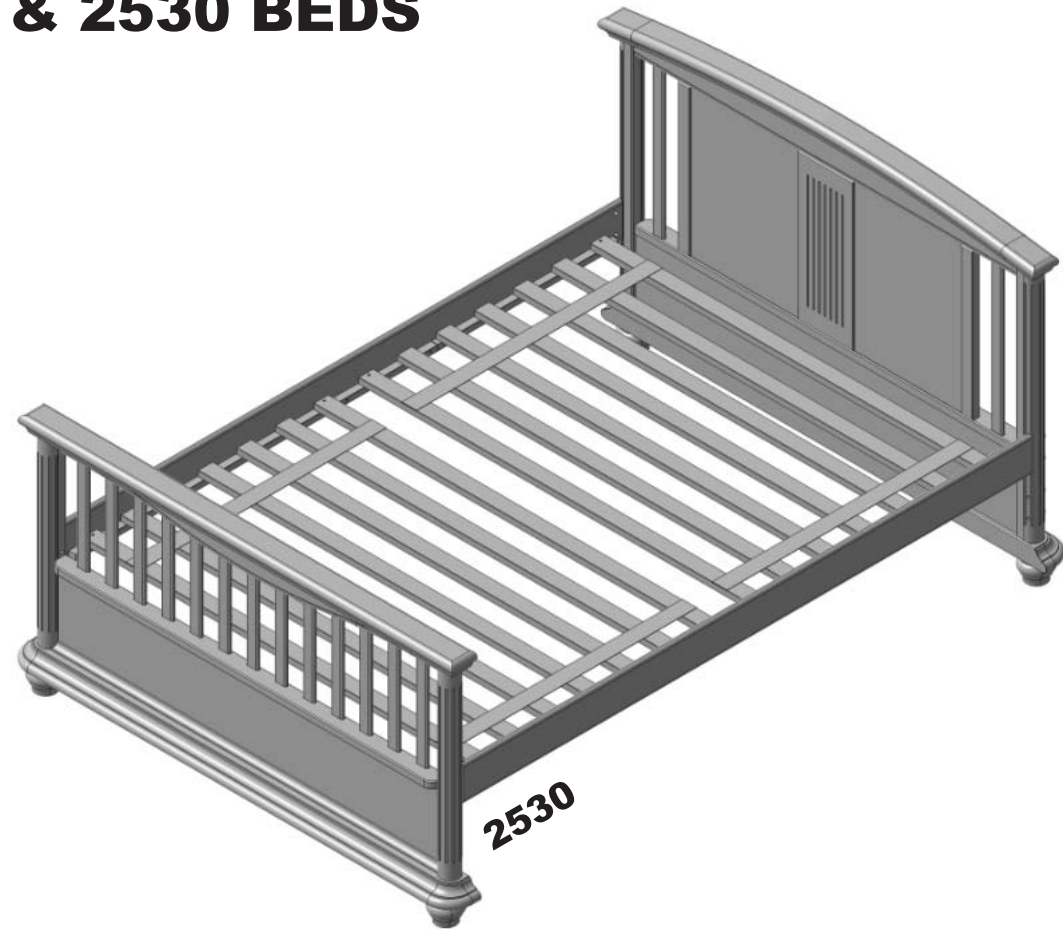
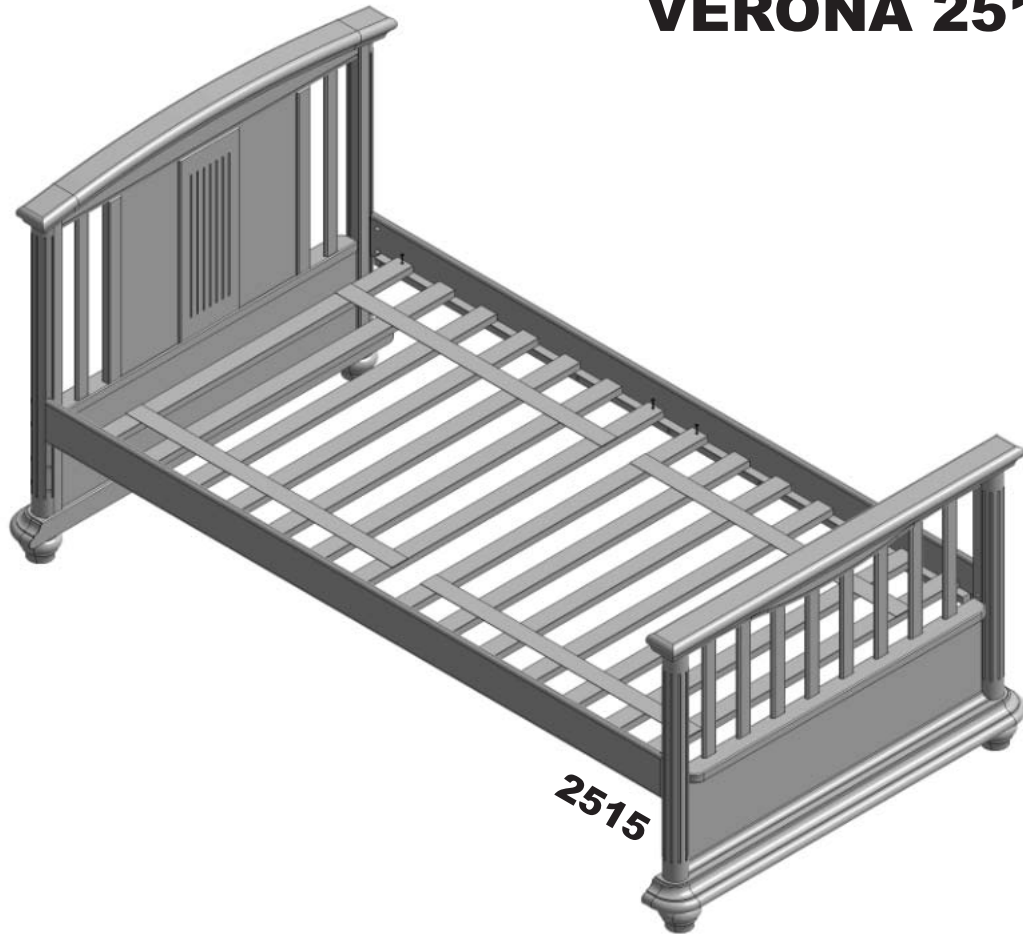

Romina[®]
Furniture

20 Corporation Row, Edison, NJ 08817
Phone (718) 478 5100, Fax (718) 478 5117
www.rominafurniture.com

**IMPORTANT: PLEASE, READ ALL
INSTRUCTIONS BEFORE ASSEMBLING! PLEASE,
SAVE INSTRUCTIONS FOR FUTURE USE**

NOTE: THE STYLE OF YOUR
BED MAY VARY FROM WHAT IS
PICTURED IN THE
INSTRUCTION SHEET

HB

FB

SL

BR

HB

FB

SL

BR

2530

2515

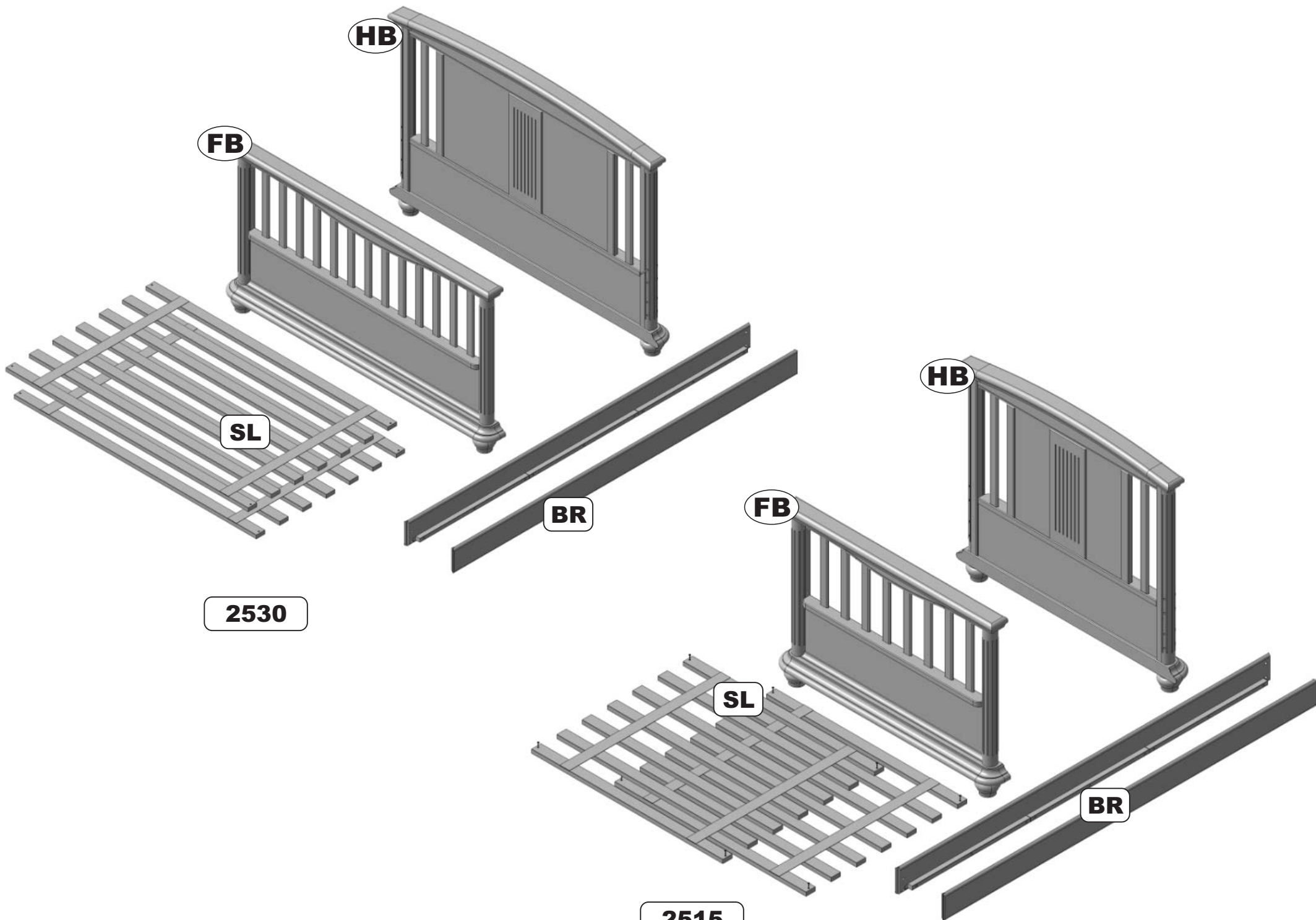

IMPORTANT:
PLEASE, READ ALL INSTRUCTIONS BEFORE ASSEMBLING!
PLEASE, SAVE INSTRUCTIONS FOR FUTURE USE

⚠ WARNING!

TO HELP PREVENT SERIOUS OR FATAL INJURIES FROM ENTRAPMENT OR FALLS:

- PROHIBIT HORSEPLAY AND JUMPING ON OR UNDER BED(S).
- PERIODICALLY CHECK AND ENSURE THAT ALL THE COMPONENTS ARE IN THEIR PROPER POSITION, FREE FROM DAMAGE, AND THAT ALL CONNECTIONS ARE TIGHT.
- DO NOT SUBSTITUTE PARTS. PLEASE, CONTACT ROMINA FURNITURE FOR REPLACEMENT PARTS.
- THE USE OF WATER OR SLEEP FLOTATION MATTRESSES IS PROHIBITED.
- PACKAGING MATERIAL, SMALL PARTS & PLASTIC BAGS ARE HAZARDOUS TO SMALL CHILDREN. PLEASE DISPOSE OF THEM IMMEDIATELY!

KEEP THESE INSTRUCTIONS FOR FUTURE REFERENCE!

**2515 & 2530
BOX CONTENT**

Please locate and confirm
you have the following parts:

- FB. - footboard = 1 (please see page 2 for footboard style, depending of your bed type)
- HB. - headboard = 1 (please see page 2 for headboard style, depending of your bed type)
- BR. - bed rail = 1+1
- SL. - group of 7 support slats assembled with 2 textile ribbons = 2

and one bag of hardware with the following:

- 1. wood screw (flat head 35mm - 1 3/8") = 8
- 2. Allen bolts (70mm - 2 3/4") = 4
- 3. barrel nuts = 4
- 4. Allen wrench = 1

COMPLETELY TIGHTEN the screws / bolts when you are asked to do this!

Regular cleaning with mild soap on a soft cloth, followed by a clean damp cloth, then a dry cloth, will preserve the original luster and beauty of this fine finish of your Romina Furniture product.

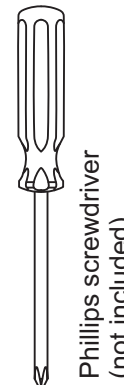
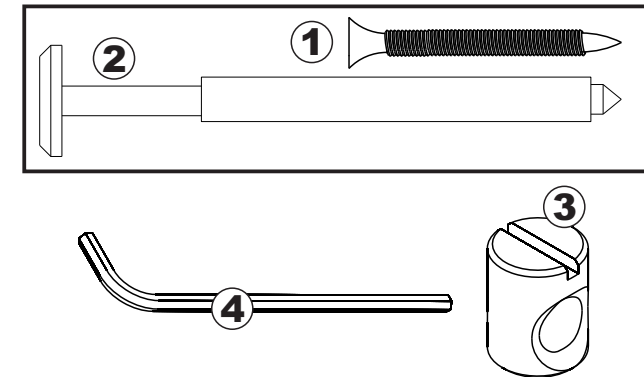

Phillips screwdriver
(not included)

Note: The letters which identifies a part are the initials of the respective part name (such method is employed to facilitate parts recognition between the drawings and the parts list).

Required tools: Phillips screwdriver (not included), Allen wrench (supplied)

CAUTION: Do not use a power screwdriver which can cause screws to break or strip

Note: The product code is located on the inner side of the headboard or footboard, on a black and white label. Please, refer to this number in the event that you need to call ROMINA FURNITURE or your local distributor. Thank you.

STEP 1 (for both beds, two adults are required to complete this step)

Attach one of the bed rails (**BR**) to the headboard (**HB**) using 2 Allen bolts (**2**) and 2 barrel nuts (**3**). Make sure that the wood brackets attached to the bed rails faces towards the inside of the bed. Align the straight slot in the head of the barrel nut horizontally, so the threads in the bolt will insert in the barrel nut. You can adjust the position of the barrel nut with a flat head screwdriver (not supplied) or a coin. Push the Allen bolts through the headboard and into the bed rail. Start the threads by hand to assure you don't strip the threads, then, use the supplied Allen wrench. Do not completely tighten the bolts at this step, you will be asked to do so later. Proceed the same for the other bed rail.

Please note that you can choose between two possible height levels for the bed rails.

After completing assembly, your bed should look like one of the beds depicted on the first page of this booklet, depending of your bed type.

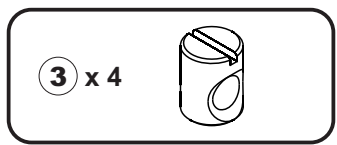
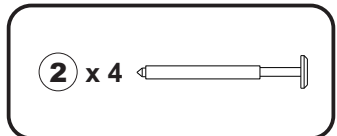
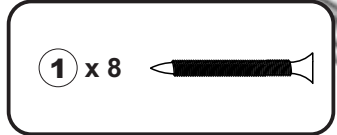
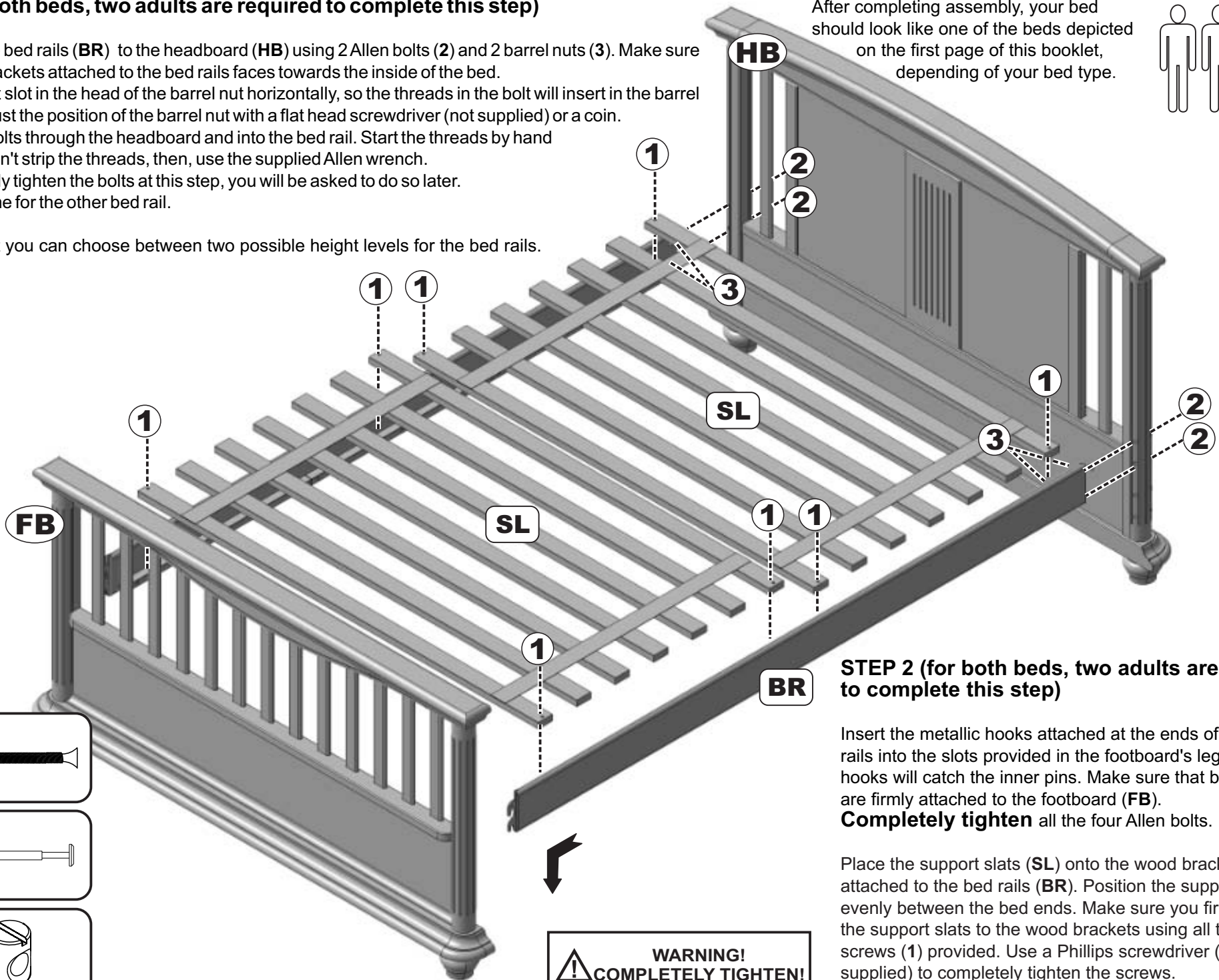
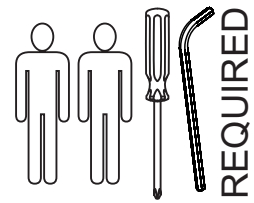

STEP 2 (for both beds, two adults are required to complete this step)

Insert the metallic hooks attached at the ends of the bed rails into the slots provided in the footboard's legs, so the hooks will catch the inner pins. Make sure that both bed rails are firmly attached to the footboard (**FB**). **Completely tighten** all the four Allen bolts.

Place the support slats (**SL**) onto the wood brackets attached to the bed rails (**BR**). Position the support slats evenly between the bed ends. Make sure you firmly attach the support slats to the wood brackets using all the 8 wood screws (**1**) provided. Use a Phillips screwdriver (not supplied) to completely tighten the screws.

WARNING!
COMPLETELY TIGHTEN!